

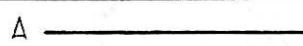





TIPO DI LINEA	DE NOMINAZIONE
A 	Continua grossa
B 	Continua fine regolare
C  D 	Continua fine irr. Continua fine reg. con zig-zag
E 	A tratti grossa
F 	A tratti fine
G 	Mista fine
H 	Mista fine, grossa alle estremita e alle variazioni di traccia piani sezioni
J 	Mista grossa
K 	Continua fine a due tratti brevi

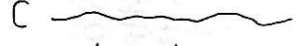
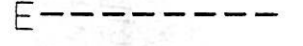
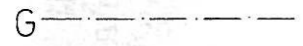
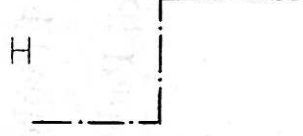
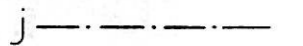
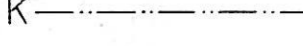
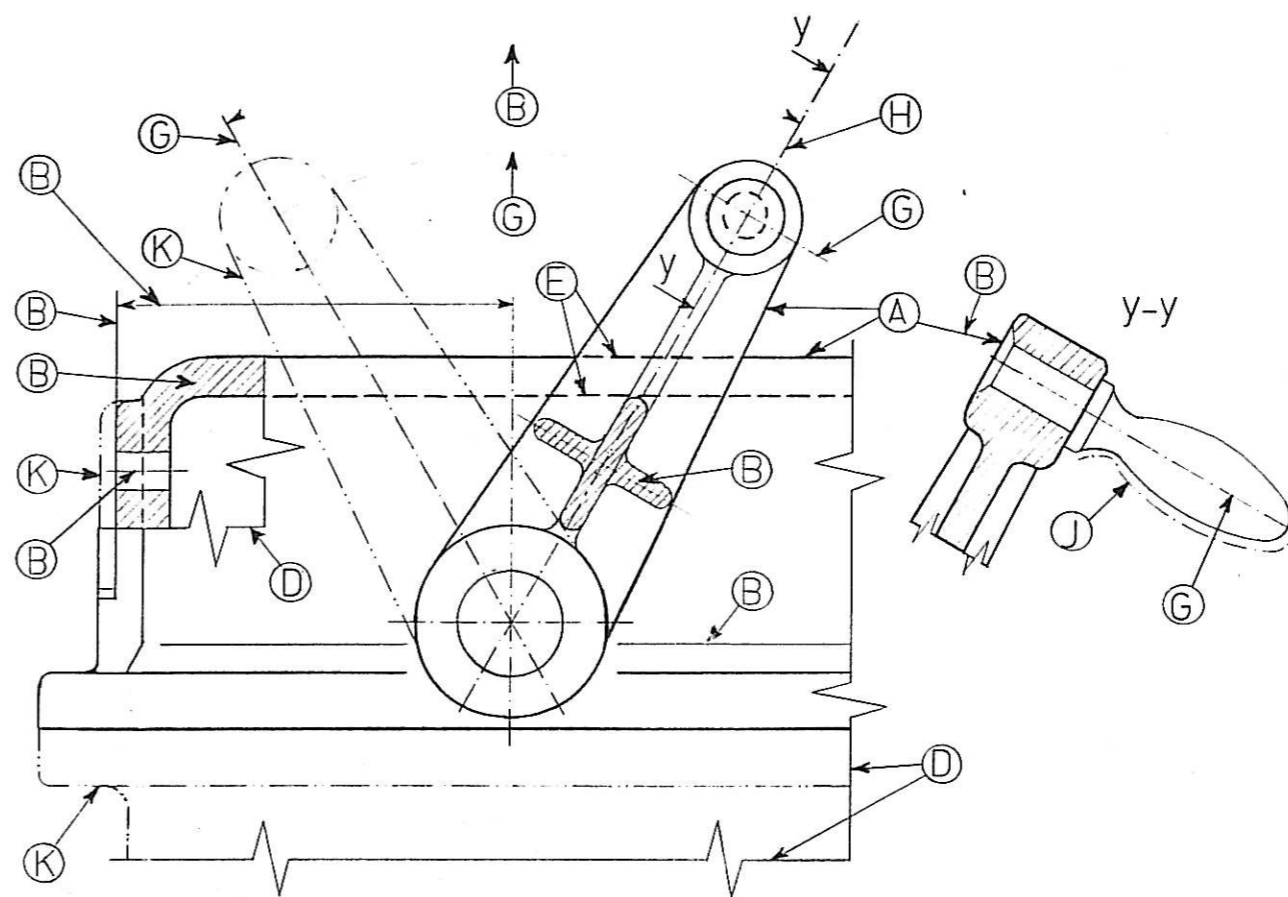

QUANT.	DENOMINAZIONE	N°	MATER.		
	UNIVERSITA DI PADOVA		SCALE	FIRME	DATE
	ISTITUTO DI DISEGNO			DIS.	
				LUC.	
				VER.	
	GOTTARDO MARCO MATR. 347349/IL		TAV. N° 1		
			SOSTITUISCE IL N°		
			SOSTITUITO DAL N°		